

Spa

Design by Ramos & Bassols

Spa is the perfect lighting solution for any wellness space. From public dressing rooms, restaurants and spas, to private kitchens, corridors and bathrooms, its graceful simplicity allows for easy cleaning and seamless integration within the surrounding architecture of a variety of interiors.

Ceiling Wall



5975



121 cm

5977



201 cm

5979



301 cm

5981



253 cm

5983



413 cm

5985

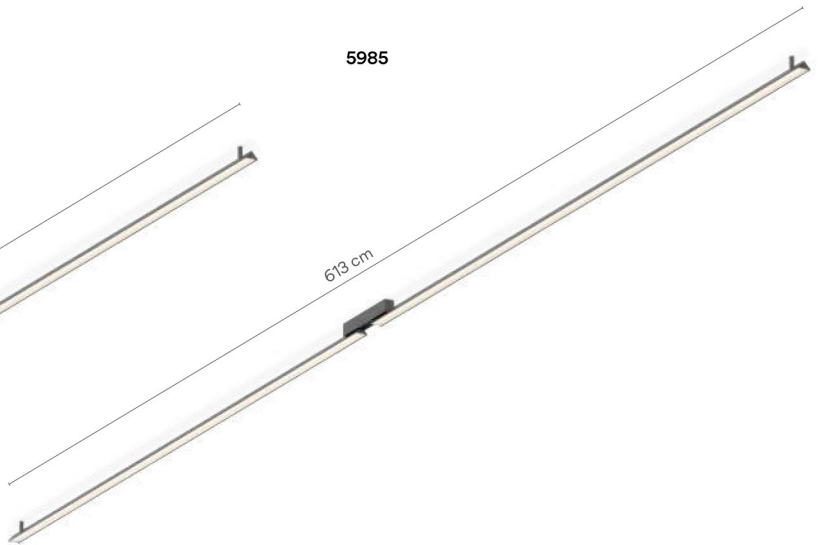

613 cm



5975

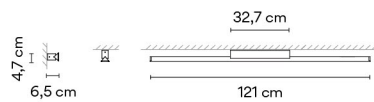

Finishes

- **11/** _ _ Black
(NCS S 8500-N)
- **23/** _ _ Warm White
(NCS S 0502-Y50R)
- **25/** _ _ Beige D1
(NCS S 4005-Y50R)

LED temperature colour

- /1 _ 2700 K CRI >90 1560 lm 144 lm/W
- /3 _ 3500 K CRI >90 1290 lm 178 lm/W

Control

- 5975** _ _ / _ 1
DALI
- 5975** _ _ / _ 3
1-10V
- 5975** _ _ / _ Z _ 30
Casambi (Remote)

Materials

Profile: Aluminum. Difuser: PMMA & Silicone.
Canopy: Aluminum.

Light Source and electronics

1 x LED STRIP 10,8 W 600 mA
Constant Current 600 mA
220~240V 50/60Hz

Packaging

1 Box 1,5 x 0,1 x 0,1 m
Vol 0,015 m³
Gross weight 3,1 Kg Net weight 1,6 Kg



5977

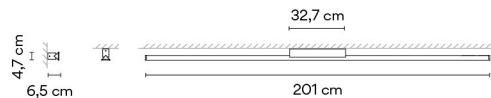

Finishes

- **11/** _ _ Black
(NCS S 8500-N)
- **23/** _ _ Warm White
(NCS S 0502-Y50R)
- **25/** _ _ Beige D1
(NCS S 4005-Y50R)

LED temperature colour

- /1 _ 2700 K CRI >90 2560 lm 119 lm/W
- /3 _ 3500 K CRI >90 3360 lm 156 lm/W

Control

- 5977** _ _ / _ 1
DALI
- 5977** _ _ / _ 3
1-10V
- 5977** _ _ / _ Z _ 30
Casambi (Remote)

Materials

Profile: Aluminum. Difuser: PMMA & Silicone.
Canopy: Aluminum.

Light Source and electronics

1 x LED STRIP 21,6 W 600 mA
Constant Current 600 mA
220~240V 50/60Hz

Packaging

1 Box 2,3 x 0,1 x 0,1 m
Vol 0,023 m³
Gross weight 4,9 Kg Net weight 2,6

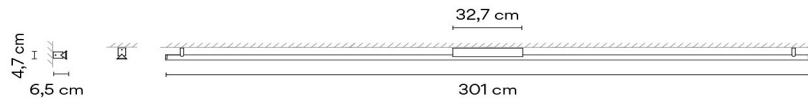

5979

**Finishes**

- **11/** __ Black
(NCS S 8500-N)
- **23/** __ Warm White
(NCS S 0502-Y50R)
- **25/** __ Beige D1
(NCS S 4005-Y50R)

LED temperature colour

- /1** _ 2700 K CRI >90 3840 lm 119 lm/W
- /3** _ 3500 K CRI >90 5040 lm 156 lm/W

Control

- 5979** __ / _ 1
DALI
- 5979** __ / _ 3
1-10V
- 5979** __ / _ Z _ 30
Casambi (Remote)

Materials

Profile: Aluminum. Difuser: PMMA & Silicone.
Canopy: Aluminum.

Light Source and electronics

1 x LED STRIP 32,4 W 600 mA
Constant Current 600 mA
220~240V 50/60Hz

Packaging

1 Box 3,3 x 0,1 x 0,1 m
Vol 0,033 m³
Gross weight 6,9 Kg Net weight 3,6 Kg

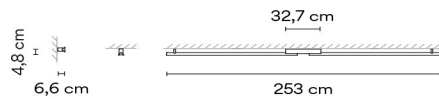

5981

**Finishes**

- **11/** __ Black
(NCS S 8500-N)
- **23/** __ Warm White
(NCS S 0502-Y50R)
- **25/** __ Beige D1
(NCS S 4005-Y50R)

LED temperature colour

- /1** _ 2700 K CRI >90 3120 lm 144 lm/W
- /3** _ 3500 K CRI >90 3840 lm 178 lm/W

Control

- 5981** __ / _ 1
DALI
- 5981** __ / _ 3
1-10V
- 5981** __ / _ Z _ 30
Casambi (Remote)

Materials

Profile: Aluminum. Difuser: PMMA & Silicone.
Canopy: Aluminum.

Light Source and electronics

2 x LED STRIP 10,8 W 600 mA
Constant Current 600 mA
220~240V 50/60Hz

Packaging

2 Boxes
Total Vol 0,030 m³
Gross weight 5,8 Kg Net weight 2,8 Kg

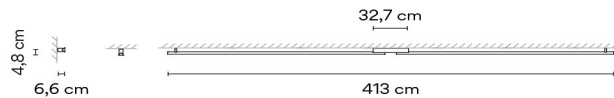

5983

**Finishes**

- **11/** __ Black
(NCS S 8500-N)
- **23/** __ Warm White
(NCS S 0502-Y50R)
- **25/** __ Beige D1
(NCS S 4005-Y50R)

LED temperature colour

- /1** _ 2700 K CRI >90 5120 lm 119 lm/W
- /3** _ 3500 K CRI >90 6720 lm 156 lm/W

Control

- 5983** __ / _ 1
DALI
- 5983** __ / _ 3
1-10V
- 5983** __ / _ Z _ 30
Casambi (Remote)

Materials

Profile: Aluminum. Difuser: PMMA & Silicone.
Canopy: Aluminum.

Light Source and electronics

2 x LED STRIP 21,6 W 600 mA
Constant Current 1200 mA
220~240V 50/60Hz

Packaging

2 Boxes
Total Vol 0,046 m³
Gross weight 9,4 Kg Net weight 4,8 Kg



5985



Finishes	LED temperature colour	Control
● 11/ __ Black (NCS S 8500-N)	/1 _ 2700 K CRI >90 7680 lm 119 lm/W	5985 __ / _1 _ 30 DALI (Remote)
● 23/ __ Warm White (NCS S 0502-Y50R)	/3 _ 3500 K CRI >90 10080 lm 156 lm/W	5985 __ / _3 _ 30 1-10V (Remote)
● 25/ __ Beige D1 (NCS S 4005-Y50R)		5985 __ / _Z _ 30 Casambi (Remote)

Materials

Profile: Aluminum. Difuser: PMMA & Silicone.
 Canopy: Aluminum.

Light Source and electronics

2 x LED STRIP 32,4 W 600 mA
 Constant Current 600 mA Remote
 220-240V 50/60Hz

Packaging

2 Boxes
 Total Vol 0,066 m³
 Gross weight 13,5 Kg Net weight 6,9 Kg



Wall Vanity light

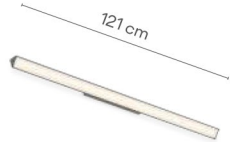

5987

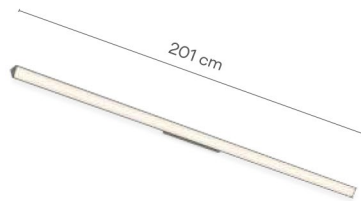

5989

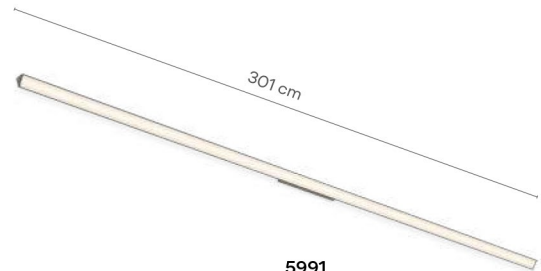

5991



5987

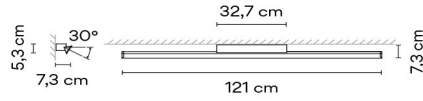

Finishes

- 11/ __ Black
(NCS S 8500-N)
- 23/ __ Warm White
(NCS S 0502-Y50R)
- 25/ __ Beige D1
(NCS S 4005-Y50R)

LED temperature colour

- /1 _ 2700 K CRI >90 1560 lm 144 lm/W
- /3 _ 3500 K CRI >90 1920 lm 178 lm/W

Control

- 5987 __ / _ 1
DALI
- 5985 __ / _ 3
1-10V
- 5985 __ / _ Z _ 30
Casambi (Remote)

Materials

Profile: Aluminum. Difuser: PMMA & Silicone.
Canopy: Aluminum.

Light Source and electronics

1 x LED STRIP 10,8 W 600 mA
Constant Current 600 mA
220~240V 50/60Hz

Packaging

1 Box 1,5 x 0,1 x 0,1 m
Vol 0,015 m³
Gross weight 3,1 Kg Net weight 1,6 Kg

Notes

Central canopy with module
LED inclined 30°



5989

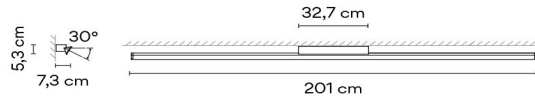

Finishes

- 11/ __ Black
(NCS S 8500-N)
- 23/ __ Warm White
(NCS S 0502-Y50R)
- 25/ __ Beige D1
(NCS S 4005-Y50R)

LED temperature colour

- /1 _ 2700 K CRI >90 2560 lm 119 lm/W
- /3 _ 3500 K CRI >90 3360 lm 156 lm/W

Control

- 5989 __ / _ 1
DALI
- 5989 __ / _ 3
1-10V
- 5989 __ / _ Z _ 30
Casambi (Remote)

Materials

Profile: Aluminum. Difuser: PMMA & Silicone.
Canopy: Aluminum.

Light Source and electronics

1 x LED STRIP 21,6 W 600 mA
Constant Current 600 mA
220~240V 50/60Hz

Packaging

1 Box 2,3 x 0,1 x 0,1 m
Vol 0,023 m³
Gross weight 4,9 Kg Net weight 2,6 Kg

Notes

Central canopy with module
LED inclined 30°



5991

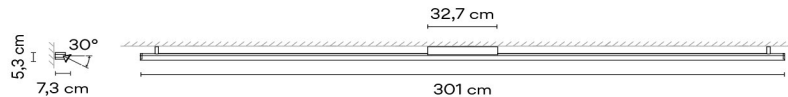

Finishes

- 11/ __ Black
(NCS S 8500-N)
- 23/ __ Warm White
(NCS S 0502-Y50R)
- 25/ __ Beige D1
(NCS S 4005-Y50R)

LED temperature colour

- /1 _ 2700 K CRI >90 3840 lm 119 lm/W
- /3 _ 3500 K CRI >90 5040 lm 156 lm/W

Control

- 5991 __ / _ 1
DALI
- 5991 __ / _ 3
1-10V
- 5991 __ / _ Z _ 30
Casambi (Remote)

Materials

Profile: Aluminum. Difuser: PMMA & Silicone.
Canopy: Aluminum.

Light Source and electronics

1 x LED STRIP 32,4 W 600 mA
Constant Current 600 mA
220~240V 50/60Hz

Packaging

1 Box 3,3 x 0,1 x 0,1 m
Vol 0,033 m³
Gross weight 6,9 Kg Net weight 3,6 Kg

Notes

Central canopy with module
LED inclined 30°



Vertical Wall

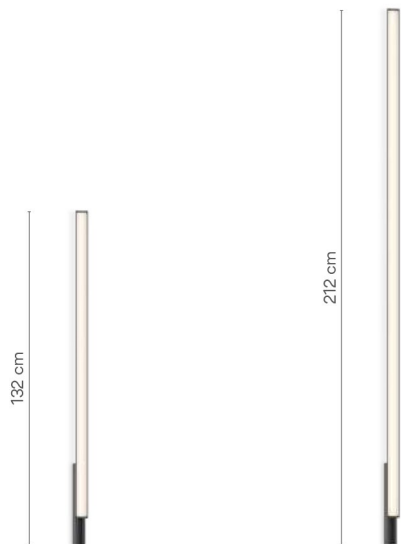

5993

5995

5993

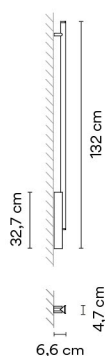

- Finishes**
- 11/ __ Black (NCS S 8500-N)
 - 23/ __ Warm White (NCS S 0502-Y50R)
 - 25/ __ Beige D1 (NCS S 4005-Y50R)

- LED temperature colour**
- /1 _ 2700 K CRI >90 1560 lm 144 lm/W
 - /3 _ 3500 K CRI >90 1920 lm 178 lm/W

- Control**
- 5993 __ / _ 1 DALI
 - 5993 __ / _ 3 1-10V
 - 5993 __ / _ Z _ 30 Casambi (Remote)

Materials

Profile: Aluminum. Difuser: PMMA & Silicone.
 Canopy: Aluminum.

Light Source and electronics

1 x LED STRIP 10,8W 600 mA
 Constant Current 600 mA
 220~240V 50/60Hz

Packaging

1 Box 1,5 x 0,1 x 0,1 m
 Vol 0,015 m³
 Gross weight 3,1 Kg Net weight 1,6 Kg



5995

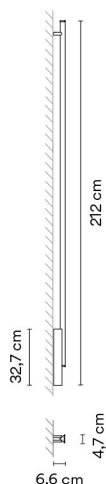

- Finishes**
- 11/ __ Black (NCS S 8500-N)
 - 23/ __ Warm White (NCS S 0502-Y50R)
 - 25/ __ Beige D1 (NCS S 4005-Y50R)

- LED temperature colour**
- /1 _ 2700 K CRI >90 2560 lm 119 lm/W
 - /3 _ 3500 K CRI >90 3360 lm 156 lm/W

- Control**
- 5995 __ / _ 1 DALI
 - 5995 __ / _ 3 1-10V
 - 5995 __ / _ Z _ 30 Casambi (Remote)

Materials

Profile: Aluminum. Difuser: PMMA & Silicone.
 Canopy: Aluminum.

Light Source and electronics

1 x LED STRIP 21,6 W 600 mA
 Constant Current 600 mA
 220~240V 50/60Hz

Packaging

1 Box 2,3 x 0,1 x 0,1 m
 Vol 0,023 m³
 Gross weight 4,9 Kg Net weight 2,6 Kg

